

# BPA SERIES

**BPA-0050**

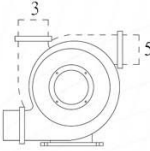

標準型 1  
Standard

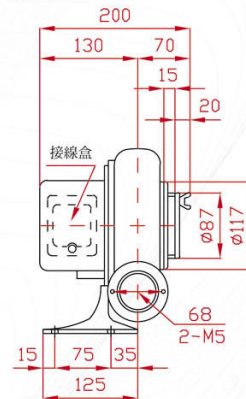
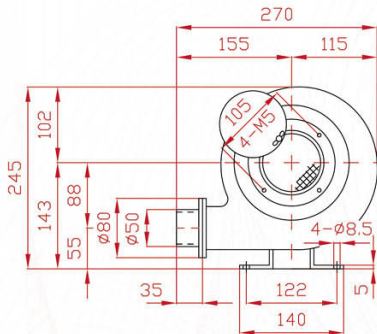

**BPA-0080**

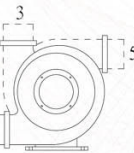

標準型 1  
Standard

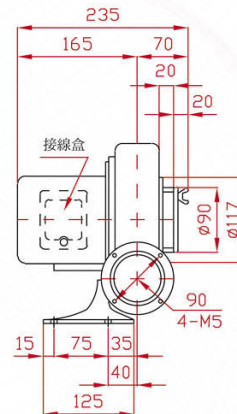
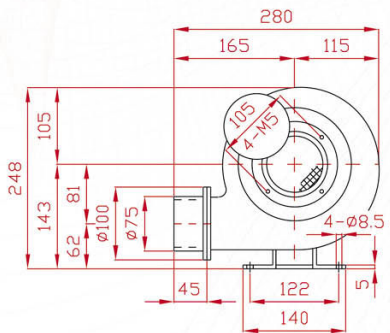

## SPECIFICATIONS

型號 TYPE	功率 KW	出口口徑 MM	電壓 V	頻率 HZ	回轉數 R.P.M.	靜壓 mmAq	最大風量 M <sup>3</sup> /MIN	噪音值 dB(A)	淨重 KG(N.W.)
BPA-0050	0.05	φ 50	請指定電壓，註一 (Note 1)	50	2800	40	2.2	45	4.7
BPA-0050L				60	3300	60	2.6	50	
BPA-0050H									
BPA-0080	0.08	φ 75	請指定電壓，註一 (Note 1)	50	2800	65	4.9	60	5
BPA-0080L				60	3300	85	5.3	65	
BPA-0080H									

說明 Instruction : L Type : 反向(Opposite direction) 、H Type : 防水隔熱型(Waterproof and heat insulation)

## BPA-0050L



## BPA-0050H

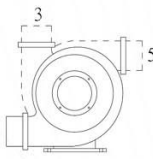

1 標準型  
Standard

標準型 1  
Standard

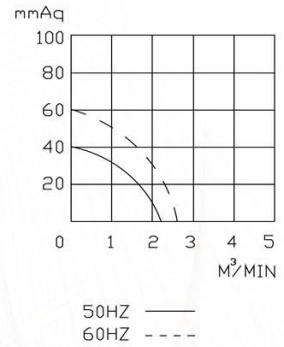
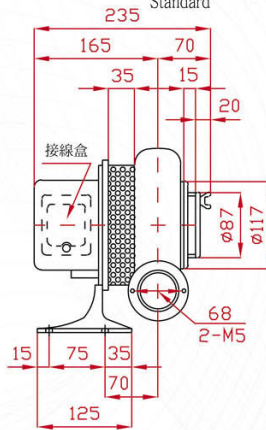
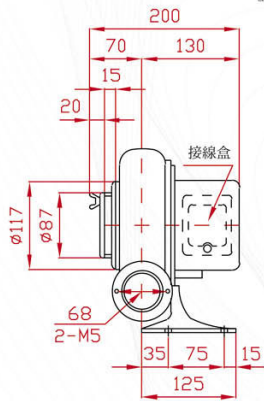

## BPA-0080L

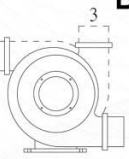

## BPA-0080H

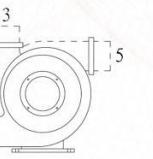

1 標準型  
Standard

標準型 1  
Standard

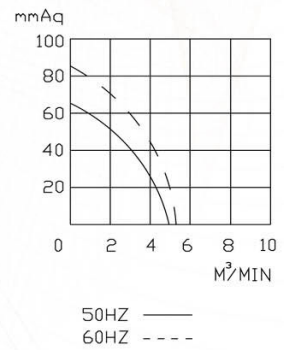
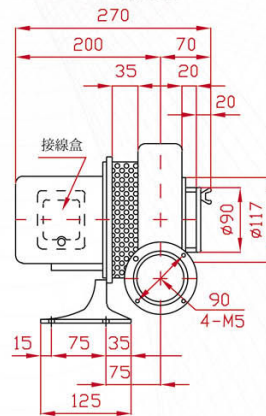
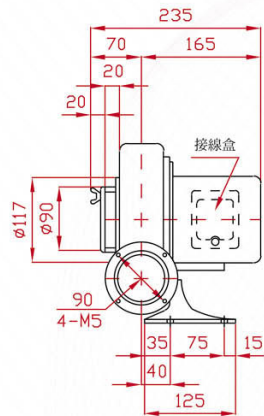

註一：供應電壓如下：單相(1 Phase)—100, 110, 120, 200, 220, 230, 240V  
(Note 1) 三相(3 Phase)—200, 208, 220, 230, 240, 346, 380, 400, 415, 440, 480, 575V

PS：訂購時請指定電壓與頻率。  
When ordering, please specify voltage and frequency.